

Tandberg

båndopptaker

TB8 (2.utgave)

1964 - 1968

Rør	ECC83/12AX7, EAM86, ECL86/6GW8, selénlikeretter B250C75
Lydhoder	2 stk, slukke og innspilling/avspilling
Antall motorer	1
Båndhastigheter	1-7/8" og 3-3/4"
Spolediameter	17 cm (7")
Forsterker	innebygget
Høytaler	permanentdynamisk, 18 x 10.5 cm, (7" x 4")
Kabinettet	teak eller montert i koffert
Fysiske mål	B(38), x H(17) x (D(30.5) cm
Spenninger	110, 125, 145, 200, 220, 245 Volt ~ vekt 9.2 kg (i koffert 10.7 kg)
Pris	TB8-23, 2 spors, kr 885.- TB8-43, 4 spors, kr 945.- (teak) TB8-24, 2 spors, kr 940.- TB8-44, 4 spors, kr 995.- (koffert)
Varianter	Teakmodellen kunne fåes med elektrisk fjernstyring, den modellen het TB8F



O5 - 2008
Copyright NRHF©

ECC 83
12AX7

ECC 86
6GW8

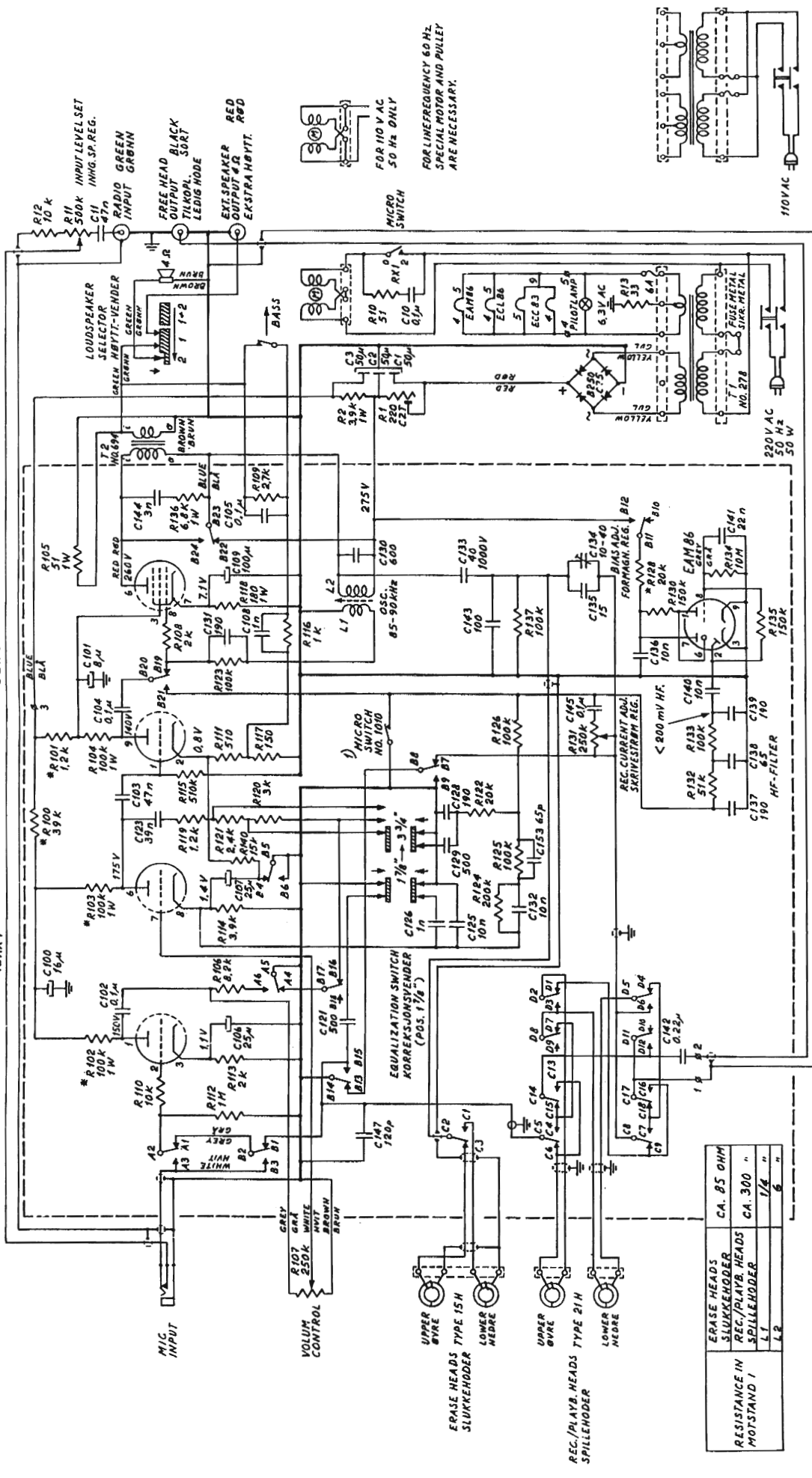

RESTISTORS:
INDICATED IN OHMS.
K = 1,000 OHMS.
M = 1,000,000 OHMS.
= DEPOSITED CARBON RESISTORS.
RESISTORS ± 10% UNLESS OTHERWISE SPECIFIED.
CAPACITORS:
INDICATED IN MICRO MICRO FARADS (μμF)
UNLESS OTHERWISE SPECIFIED.
n = 1000 μμF.
CAPACITORS ± 20%.

1) TO PREVENT DC PULSES TO PASS THROUGH THE REC./PLAYB. HEAD, THIS MICRO SWITCH MUST SHORTCIRCUIT BEFORE ANY OTHER CONTACTS ARE MADE WHEN THE B SWITCH MOVES FROM "RECORD" TO "PLAYBACK". FOR A HINDRE AT LINESTRØMSPULSER PAS-SERER GJENNOM SPILLEHODET, SKAL MICRO-KONTAKTEN KORTSLUTTE FØR NOEN ANNEN-DE B BEVEGER SEG FRA "RECORD" TIL "PLAYBACK".

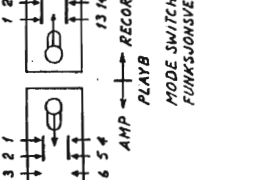
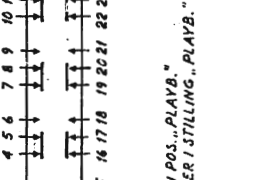
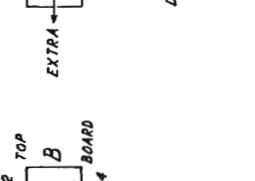
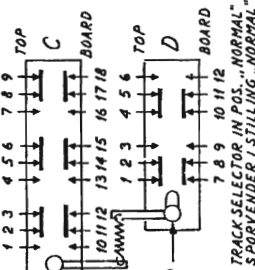

ERASE HEADS SLUKKEHODER	CA. 85 OHM
REC./PLAYB. HEADS SPILLEHODER	CA. 300 "
L1	1/4 "
L2	6 "

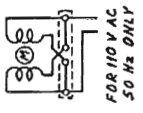

FOR LINE FREQUENCY 60 Hz SPECIAL MOTOR AND PULLEY ARE NECESSARY.

FOR 110 V AC 50 Hz ONLY

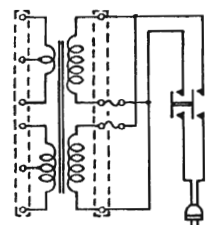

110V AC

220V AC
50 Hz
50 W